

Art. Nr. 4431296

1/7



17.03.2025

Art. Nr. 4431296

Grundplan - Grundplan - Plan de masse -
Planimetria - Plattegrond - Põhiplaan

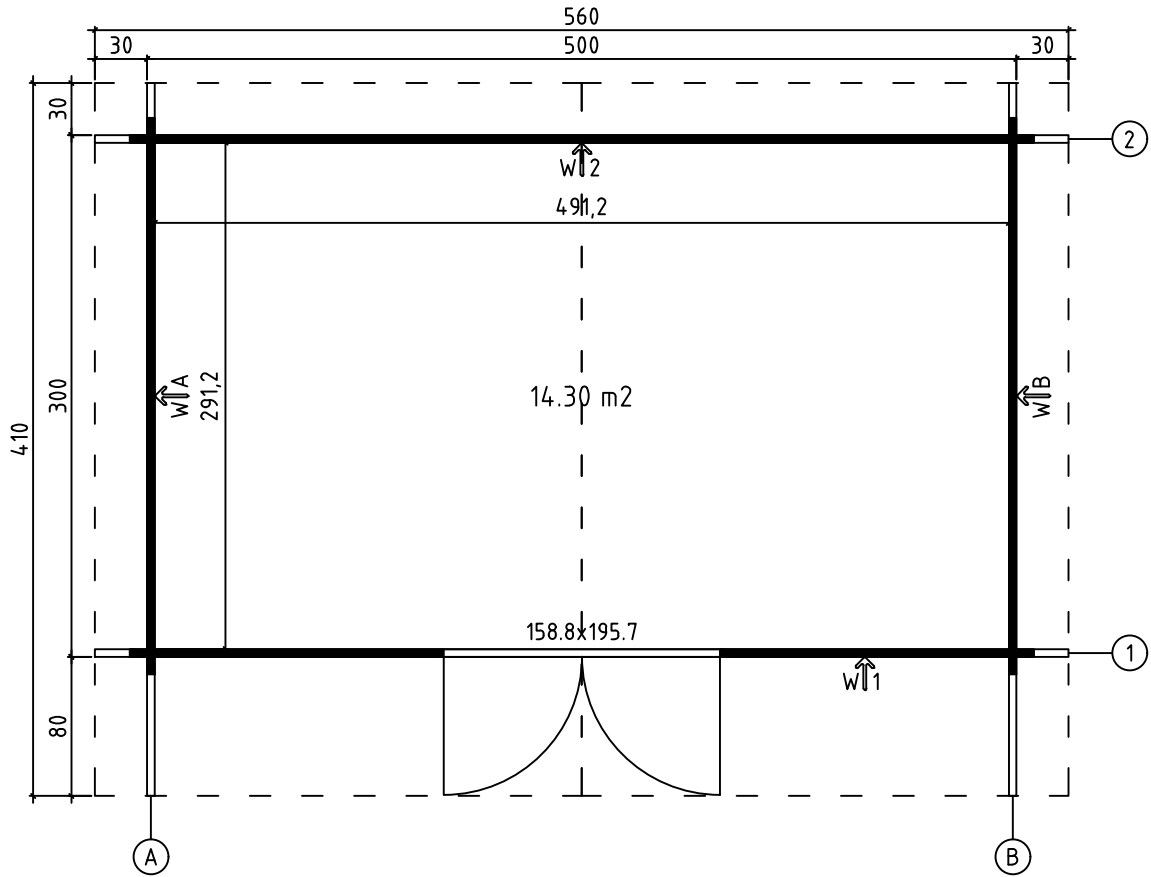

Roof plan - Dach-plan - Plan du toit -
Piano del tetto - Dak plattegrond - Katuseplaan

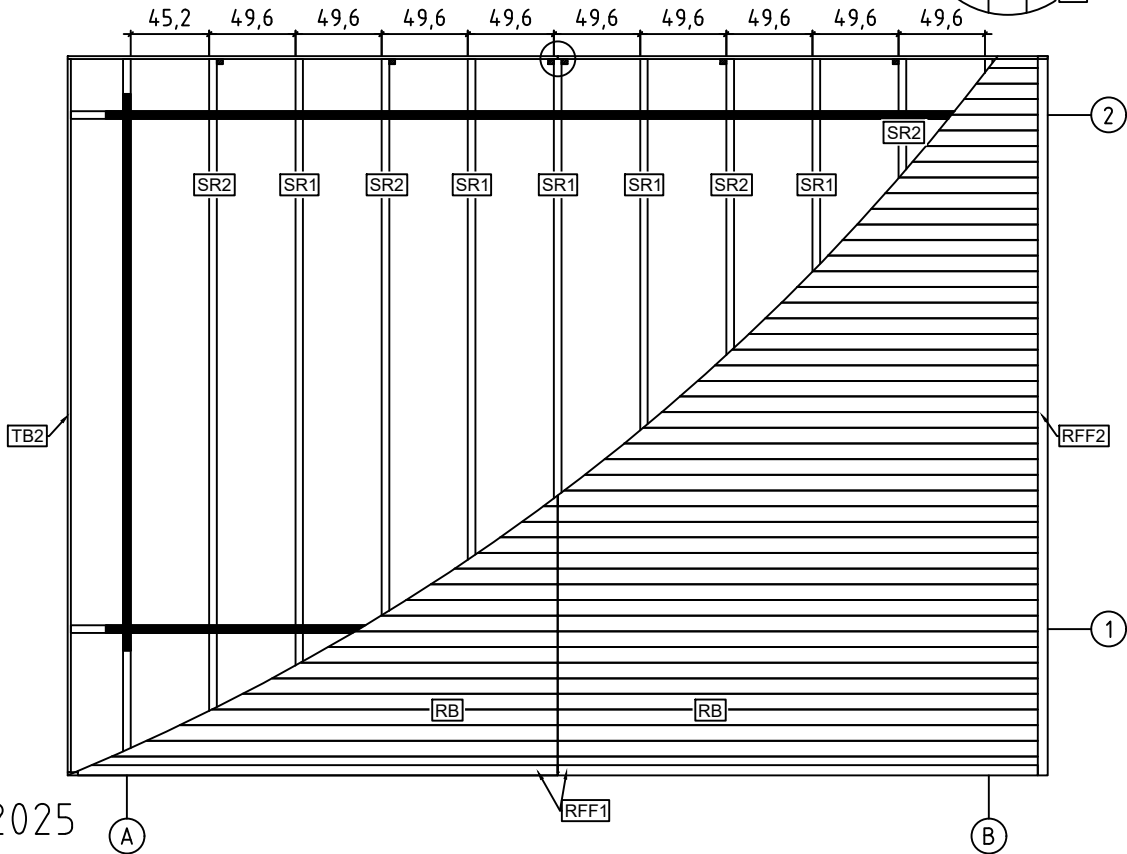
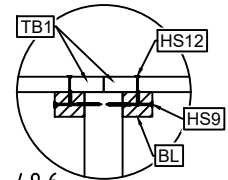





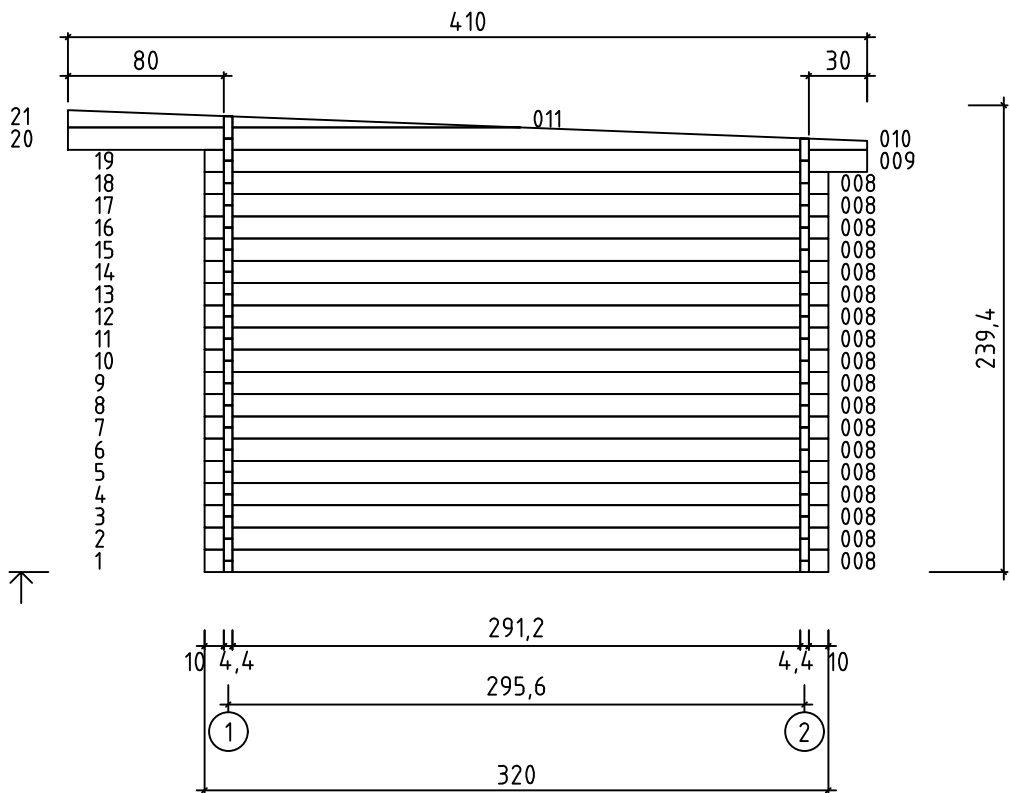
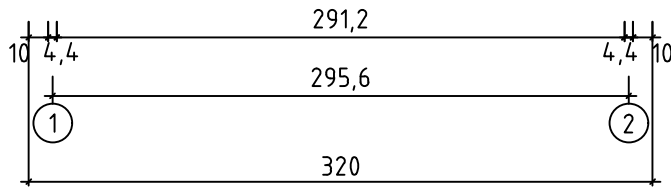
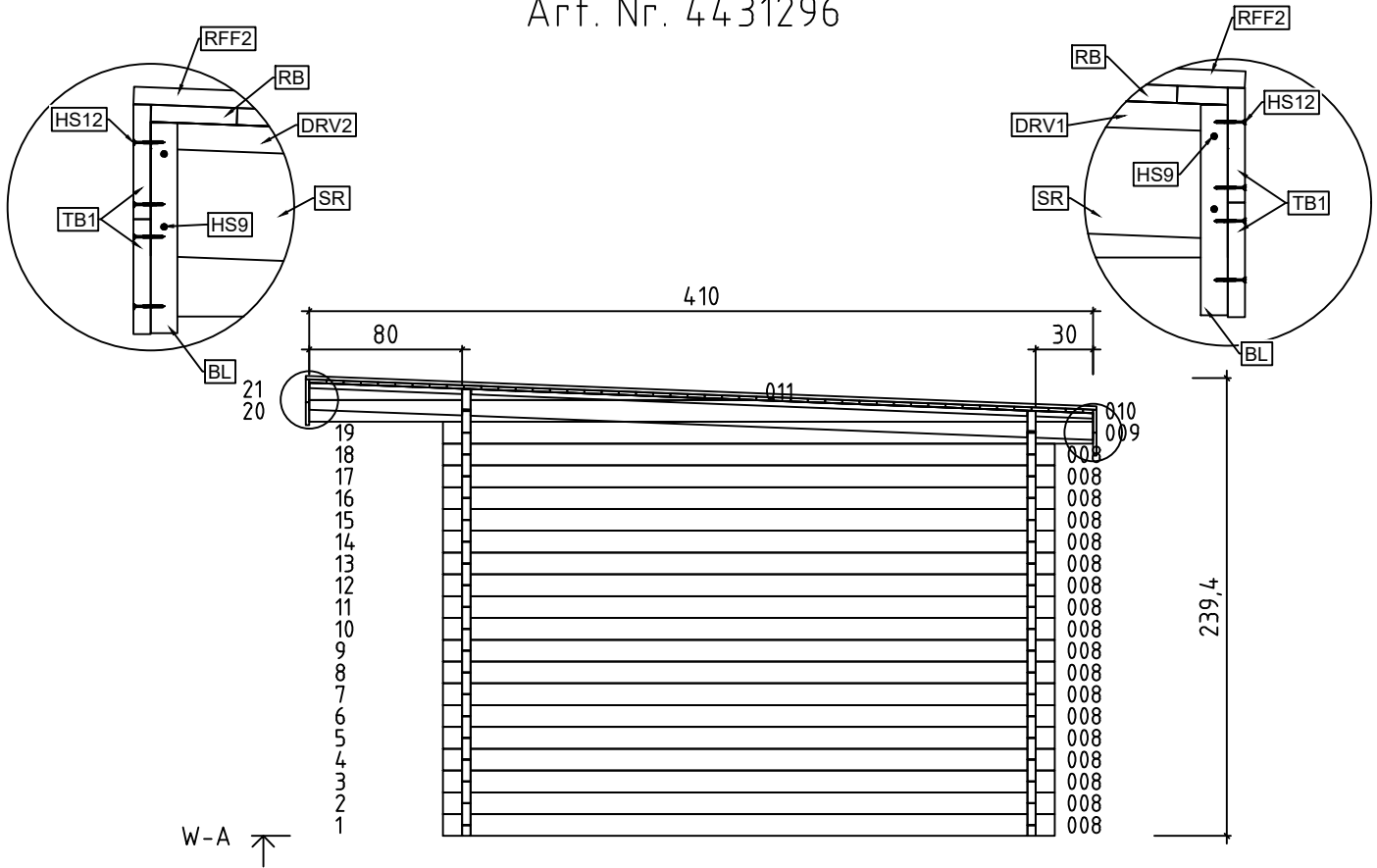

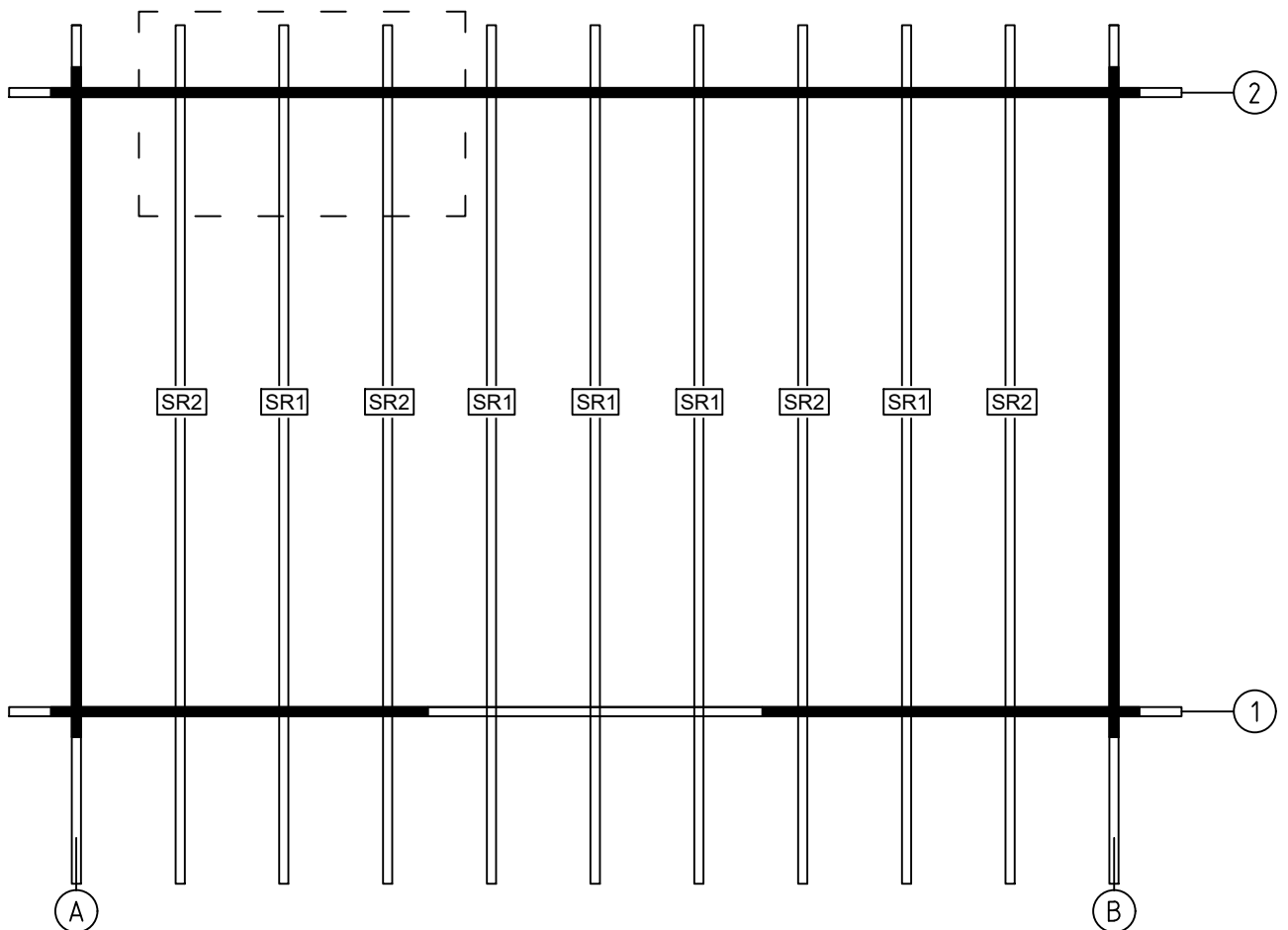
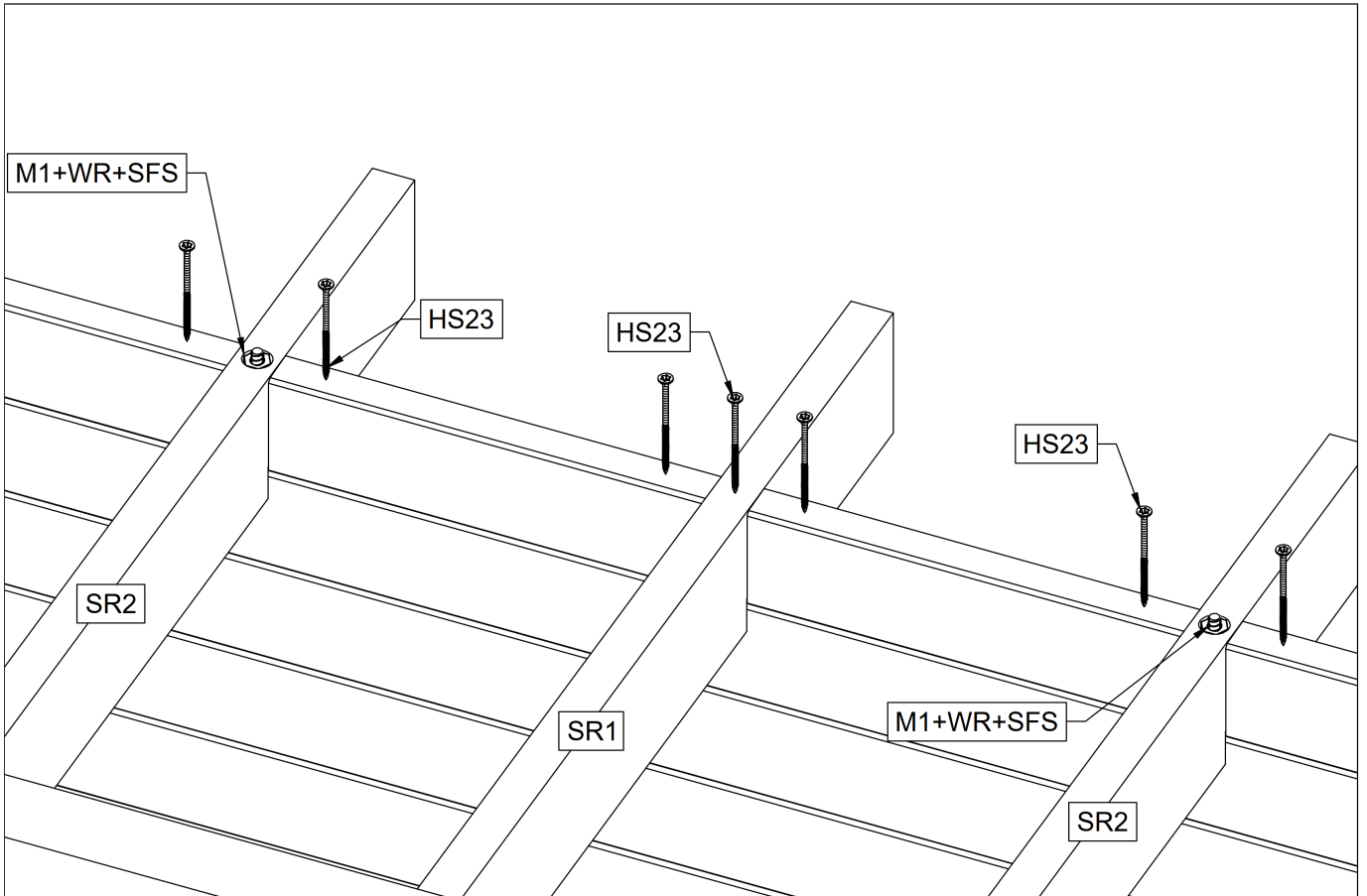

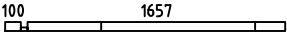
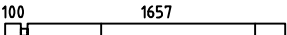
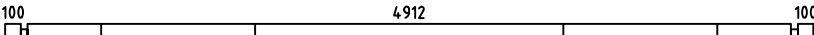
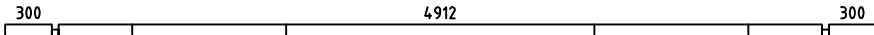
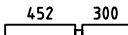

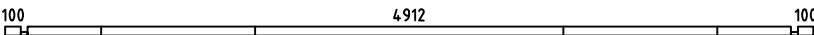
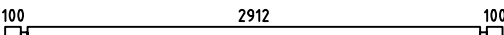
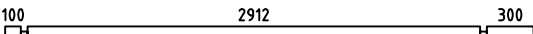
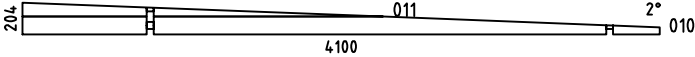
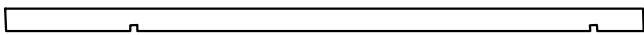
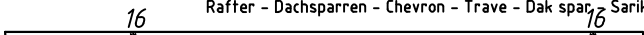



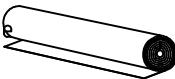
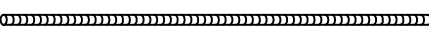
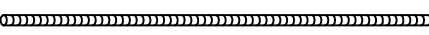
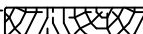

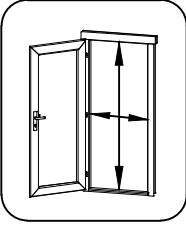
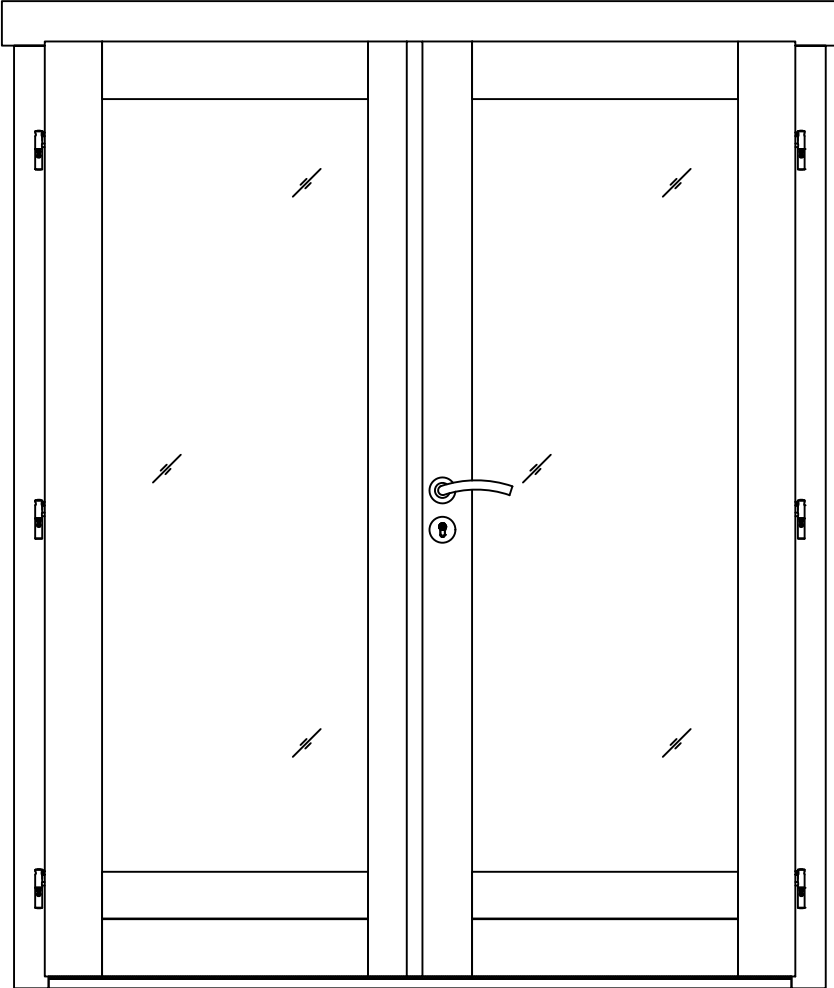

17.03.2025

Art. Nr. 4431296

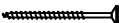
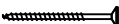

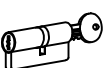

Pos	17.03.2025 Piece list - Stückliste - Liste des pièces - Elementi - Stuklijst - Tükítabel Art. Nr. 4431296 6/7	Q	P (mm)	L (mm)
001 47482		2	44x57	1801
002 47483		34	44x114	1801
003 47484		18	44x114	5200
004 47485		2	44x114	5600
005 47486		4	44x114	796
006 47487		16	44x114	452
007 47488		1	44x57	5200
008 19952		36	44x114	3200
009 30457		2	44x114	3400
WA-1 WB-1 30460		1		
SR1 30461	Rafter - Dachsparren - Chevron - Trave - Dak spar - Sarikas 	5	44x146	4109
SR2 47489	Rafter - Dachsparren - Chevron - Trave - Dak spar - Sarikas 	4	44x146	4109
RB 1762	Roof boards - Dachbretter - Voliges - Perlina per tetto - Dakhout - Katuselaud 	92	90x18.5	2800
RFF1 22612	Roofing felt fillet - Dachpappenleiste - Baguette de fixation du feutre bitumeux - Asse per fissaggio guaina bituminosa - Afdekljst asfaltpapier - Katusepapiilist 	2	18x58	2760
RFF2 30465	Roofing felt fillet - Dachpappenleiste - Baguette de fixation du feutre bitumeux - Asse per fissaggio guaina bituminosa - Afdekljst asfaltpapier - Katusepapiilist 	2	18x58	4139
DPP-1	Roofing felt (strip) - Dachpappe (bahnen) - Feutre bitumeux (bande) - Cartone catramato - Asfaltpapier (baan) - Fieltra para tejado - Katusepapp 	5		5700
M2 49032	Treaded rod m10 - Gewindestange m10 - Tige filetée m10 - Barra filettata passo m10 - Draadstang 10m - Keermelatt 	8		1000
M1 49032	Treaded rod m10 - Gewindestange m10 - Tige filetée m10 - Barra filettata passo m10 - Draadstang 10m - Keermelatt 	8		2000
TB1 22615	Fascia board - Traufbrett - Bandeau de toit - Finitura lati tetto - Gevellijst - Räästalaud 	8	18x120	2818
TB2 30469	Fascia board - Traufbrett - Bandeau de toit - Finitura lati tetto - Gevellijst - Räästalaud 	4	18x120	4108
DRV1 5223	Roof edge reinforcement - Dachrandverstärkung - Corniere de renfort de bord de toit - Rinforzo x tetto - Dakrand versterking - Räästatugevdus 	2	28x34	300
DRV2 5224	Roof edge reinforcement - Dachrandverstärkung - Corniere de renfort de bord de toit - Rinforzo x tetto - Dakrand versterking - Räästatugevdus 	2	28x34	800
DRV3 30466	Roof edge reinforcement - Dachrandverstärkung - Corniere de renfort de bord de toit - Rinforzo x tetto - Dakrand versterking - Räästatugevdus 	2	28x34	2910

Pos	11.03.2025	Piece list - Stückliste - Liste des pièces - Elementi - Stuklijst - Tükítabel 1588x1957 TUK.1.100.TPVP.MMY DGP+	1/1	Q	P (mm)	L (mm)
Glass size - Glasgröße - Taille de la vitre - Misura del vetro - Glas afmeting - Klaasi mõõt: 561x1593 mm				 1488x1873 mm		
						
HS4	Screw for door fillet - Schraube zur Befestigung türleiste - Vis pour fixation baguette d'arrêt de porte - Viti per massellino della porta - Schroef voor deurlijst - Kruvi ukse kokkuvaltšiliistule				5	3x30
HS16	Screw for door jamb - Schraube für Türrahmen - Vis de fixation partie haute avec montants du cadre de porte - Viti x fissaggio montanti porte - Schroef voor deurkozijn - Kruvi ukse lengile				4	5x90
HS25	Screw for doorstep - Schrauben für Swelle - Vis pour fixation barre de seuil - Vite per soglia della porta - Schroef voor deurdorpel - Kruvi lävepakule				3	4.5x65
MH	Male bolt hinge for door - Türband - Partie male de paumelle de porte - Cerniera anube x porta - Scharnier bout - Reguleeritav polthing isane				6	14x80
HC	Covers for door hinges - Schutzkappe für Türband - Couverture de paumelle de porte - Copertura delle cerniere della porta - Afdek kap voor deurscharnier - Reguleeritava polthinge kate				12	
TL4	Door handle fittings - Türgriff - Poignée de porte - Maniglia - Deurhendel / klink - Ukse käepide				1	
TL5	Set of door lock covers - Schlossblenden - Set de garnitures de porte - Copertura serrature - Slot sluitplaat set - Ukse lukuplaat				2	
38890	Cylinder lock - Zylinderschloss - Barillet de porte - Serratura - Cylinder slot - Ukse lukusüdamik				1	30x70
	Striker for barrel bolt - Hülse für Grendelriegel - Gache au sol du targette - Boccola per fermo della porta - Huls voor vergrendelingsschuif - Vasturaud ukse servariivile				2	