

*Hlid*  
*Art. Nr. 3421802*  
*1/7*

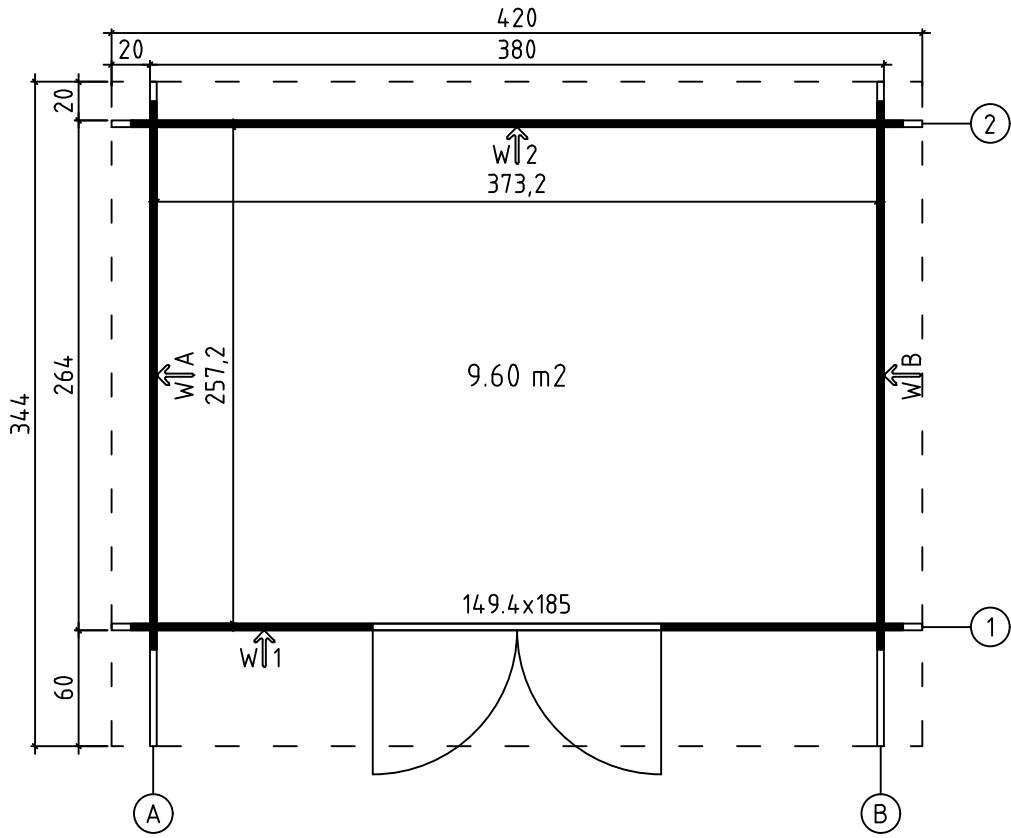

Art. Nr. 3421802

Groundplan - Grundplan - Plan de masse -  
Planimetria - Plattegrond - Põhiplaan



Roof plan - Dach-plan - Plan du toit -  
Piano del tetto - Dak plattegrond - Katuseplaan

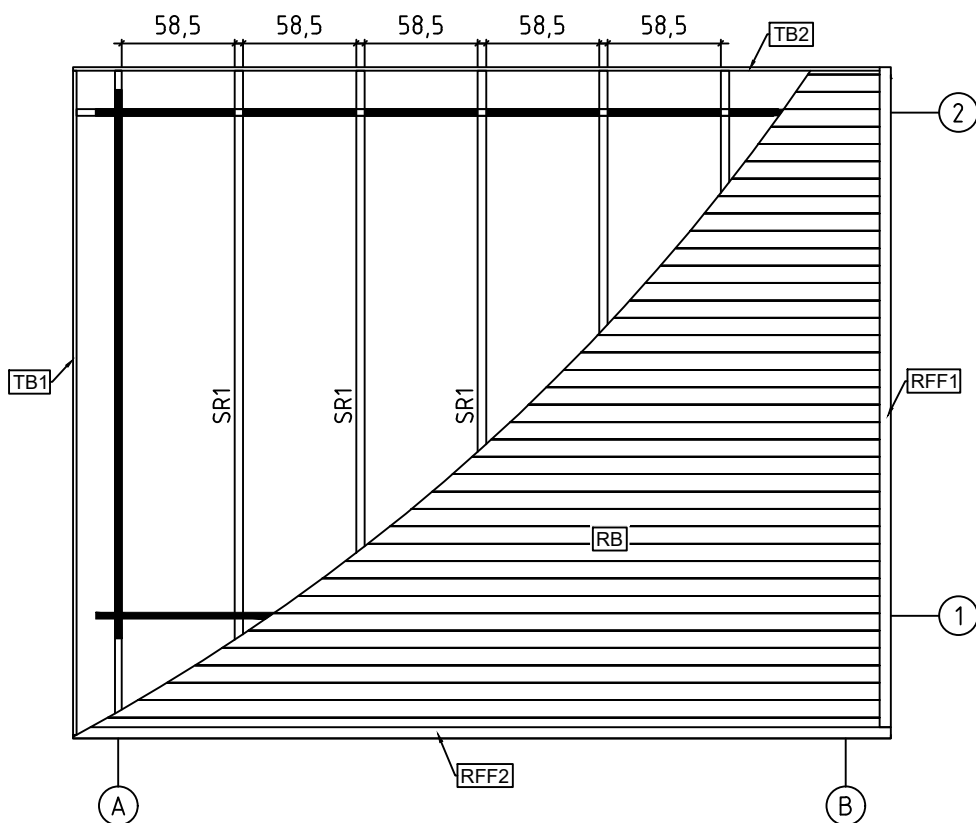

Foundation - Fundament - Fondation -  
Fondamenta - Fundering - Immutatud alusraam

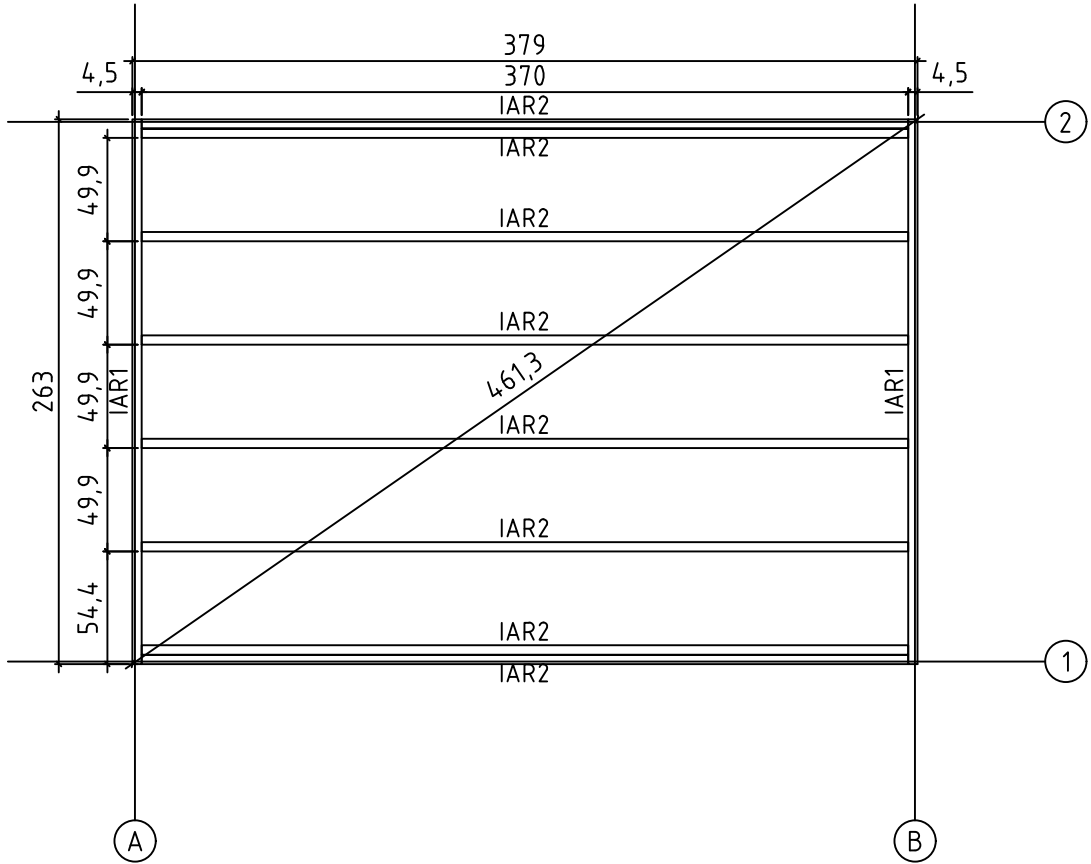

Floor boards - Fussbodenbretter - Plan pose plancher -  
Pavimento - Vloerhout - Põrandalaudis

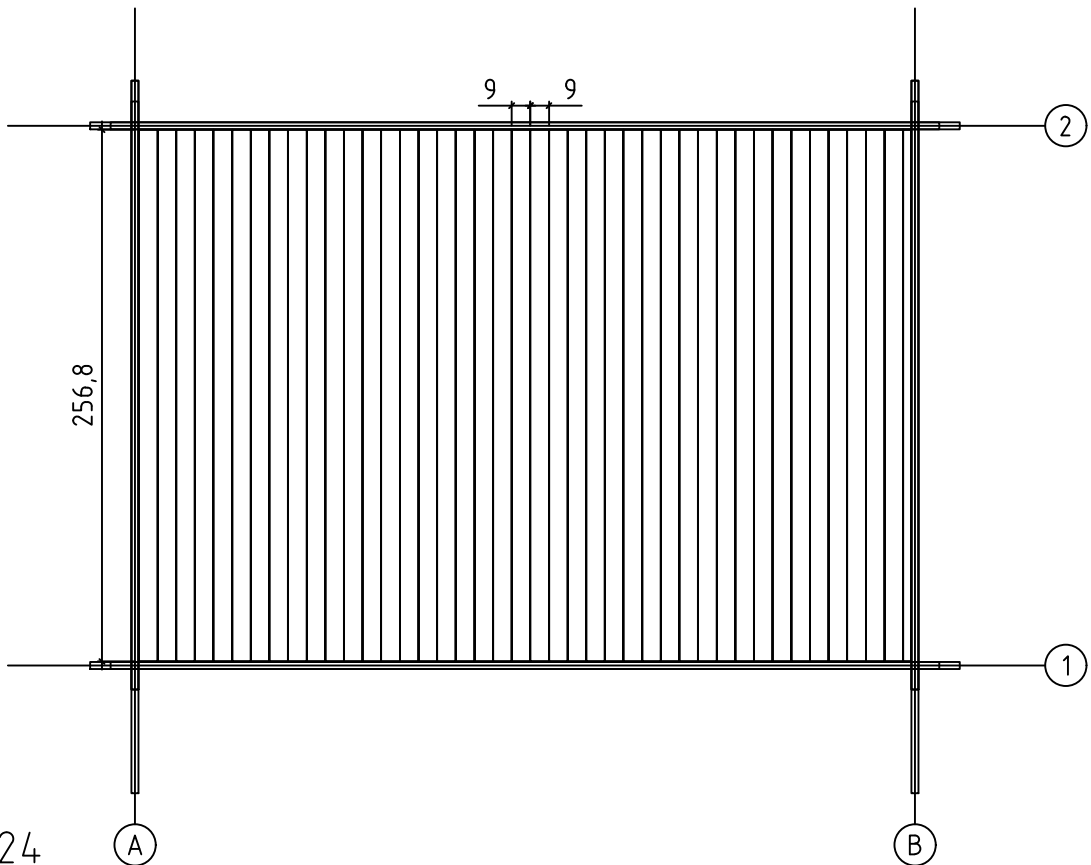



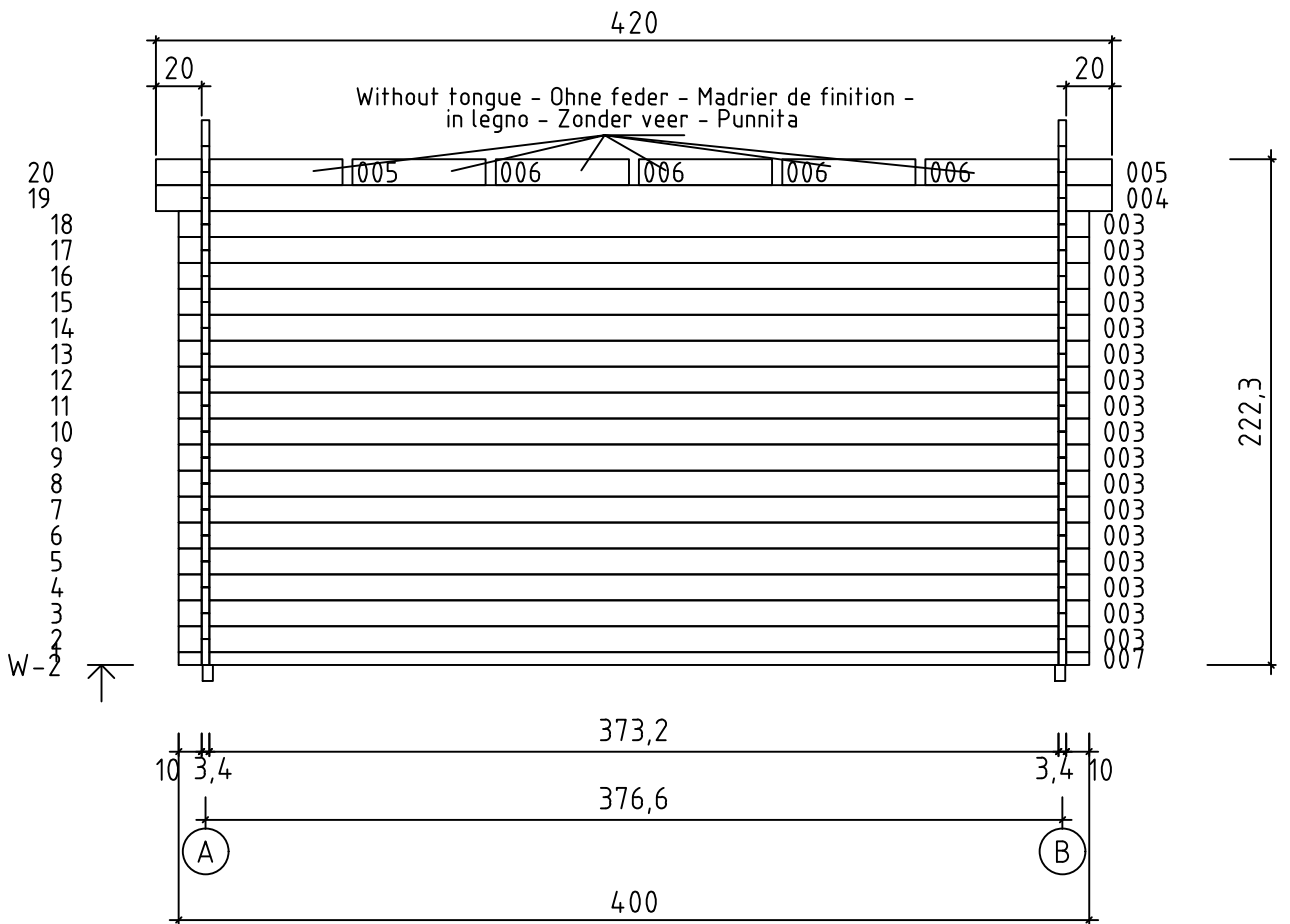
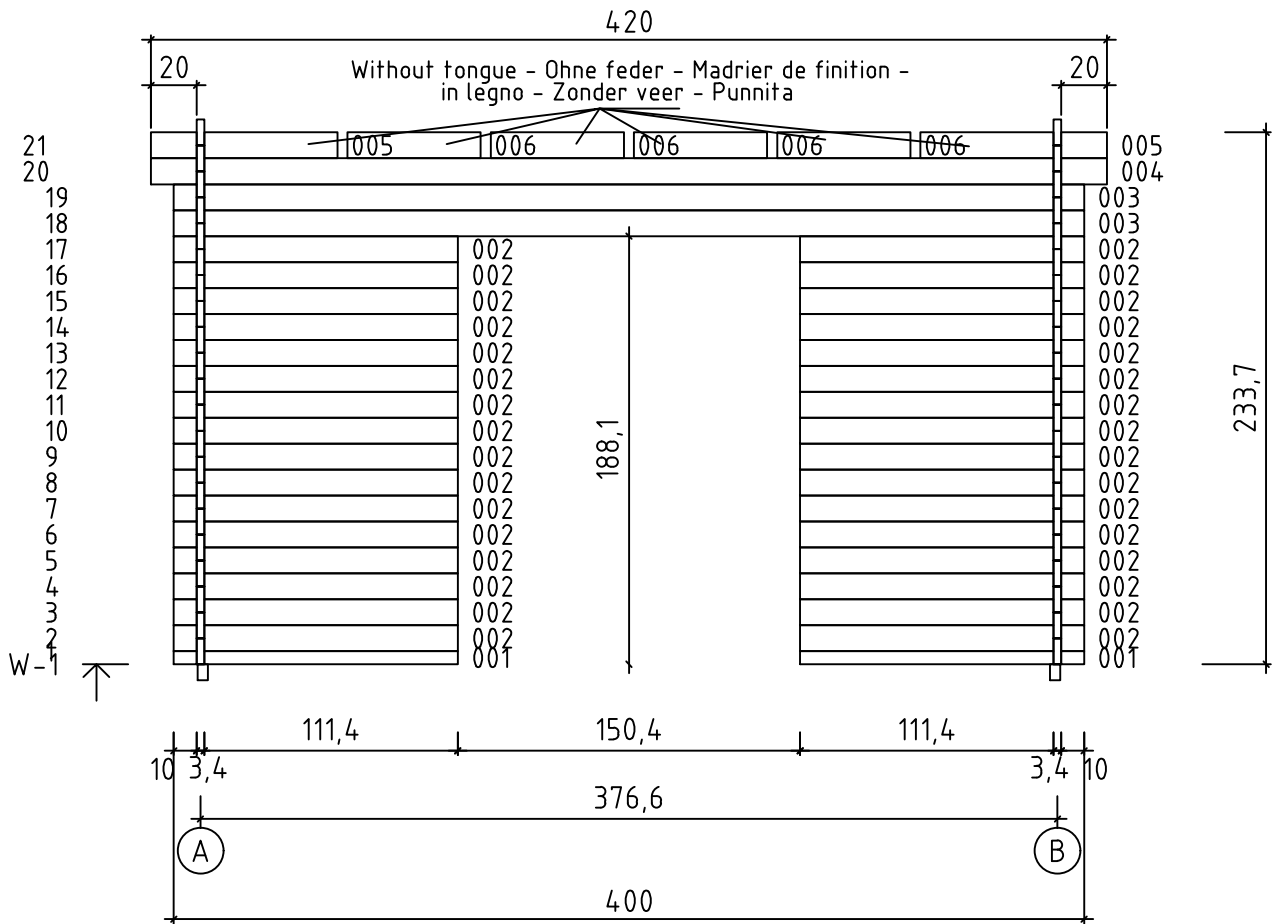



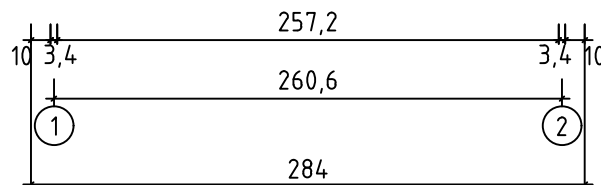
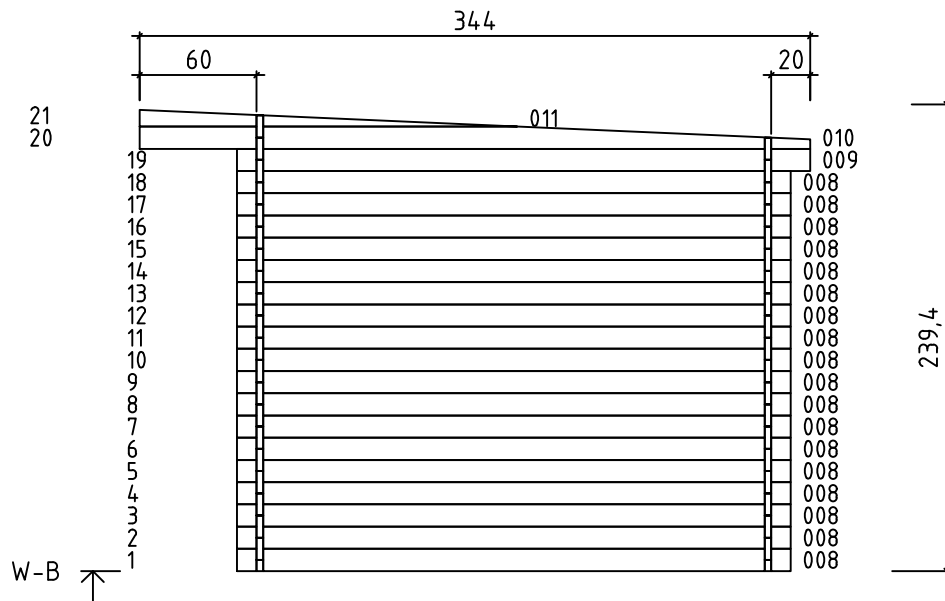
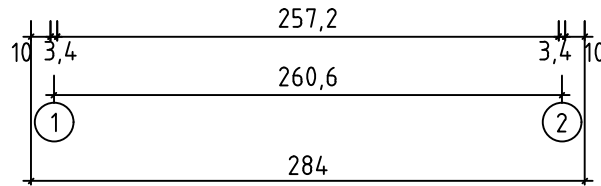
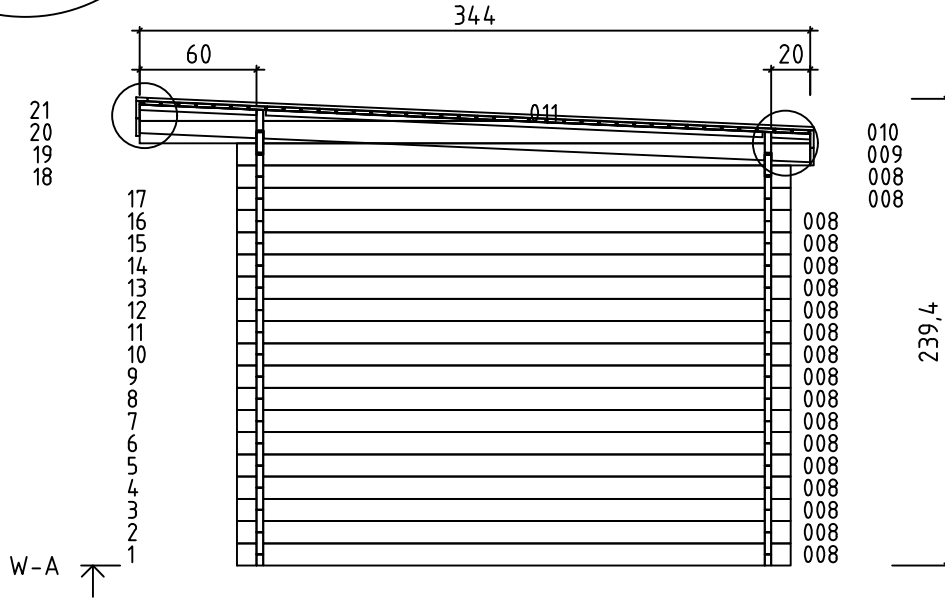
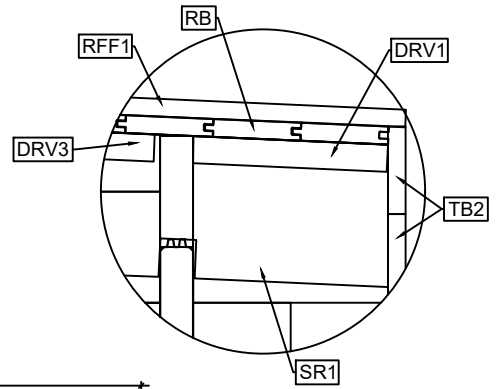
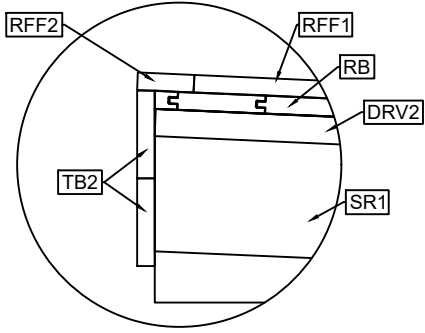

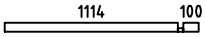
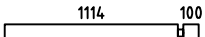
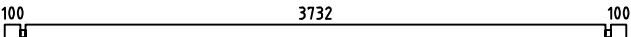
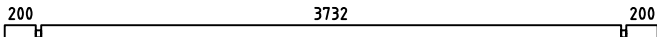
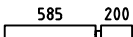

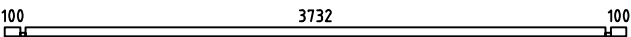
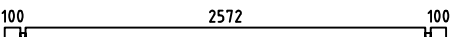
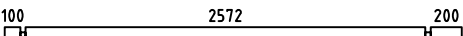
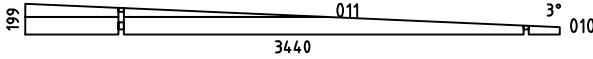
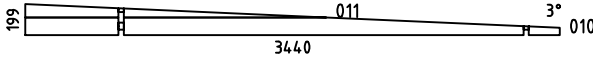

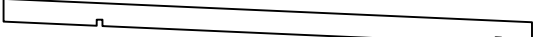
Art. Nr. 3421802





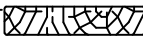
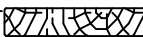



Art. Nr. 3421802

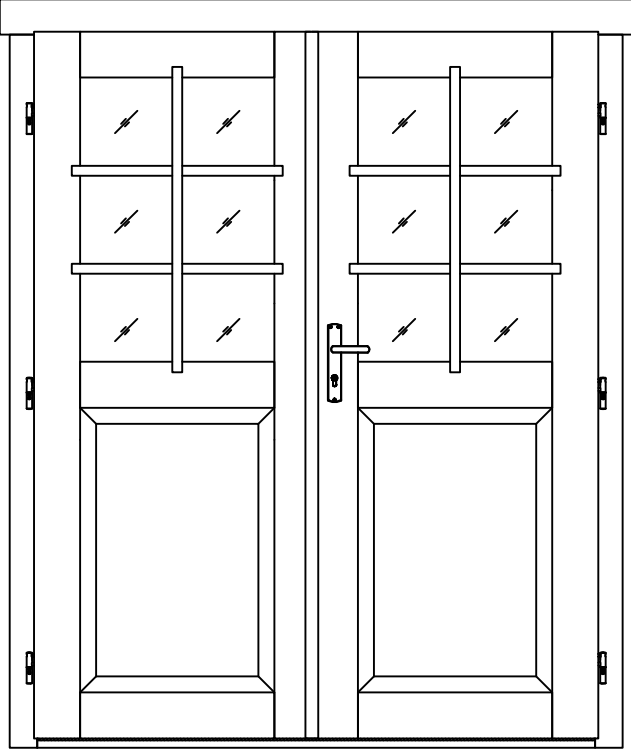
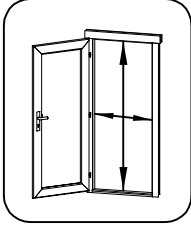
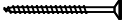
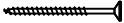
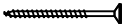
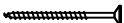

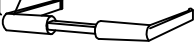
Pos	12.04.2024 Piece list - Stückliste - Liste des pièces - Elementi - Stuklijst - Tükitalabel Art. Nr. 3421802	6/7	Q	P (mm)	L (mm)
001			2	34x57	1248
002			32	34x114	1248
003			19	34x114	4000
004			2	34x114	4200
005			4	34x114	819
006			8	34x114	585
007			1	34x57	4000
008			36	34x114	2840
009			2	34x114	2940
WA-1			1		
WB-1			1		
IAR2	Foundation - Fundament - Fondation - Fondamenta - Fundering - Immutatud alusraam 		8	45x70	3700
IAR1	Foundation - Fundament - Fondation - Fondamenta - Fundering - Immutatud alusraam 		2	45x70	2630
SR1	Rafter - Dachsparren - Chevron - Trave - Dak spar - Särikas 		5	44x146	3444
FB-1	Floor boards - Fussbodenbretter - Lame de plancher - Pavimento - Vloerhout - Põrandalaud 		42	90x18.5	2568
RB	Roof boards - Dachbretter - Voliges - Perlina per tetto - Dakhout - Katuselaud 		39	90x18.5	4200
FL-1	Floor fillet - Fussbodeneiste - Corniere de finition du plancher - Finitura per pavimento (battisco pa) - Vloerafwerkljst - Põrandaliist 			18x18	14
RFF1	Roofing felt fillet - Dachpappenleiste - Baguette de fixation du feutre bitumeux - Asse per fissaggio guaina bituminosa - Afdekljst asfaltpapier - Katusepapiliist 		2	18x58	3420
RFF2	Roofing felt fillet - Dachpappenleiste - Baguette de fixation du feutre bitumeux - Asse per fissaggio guaina bituminosa - Afdekljst asfaltpapier - Katusepapiliist 		1	18x58	4236
TB1	Fascia board - Traufbrett - Bandeau de toit - Finitura lati tetto - Gevelljst Räästalaud 		4	18x90	3447
TB2	Fascia board - Traufbrett - Bandeau de toit - Finitura lati tetto - Gevelljst Räästalaud 		4	18x90	4236
DRV1	Roof edge reinforcement - Dachrandverstärkung - Corniere de renfort de bord de toit - Rinforzo x tetto - Dakrand versterking - Räästatugevdus 		2	44x44	200
DRV2	Roof edge reinforcement - Dachrandverstärkung - Corniere de renfort de bord de toit - Rinforzo x tetto - Dakrand versterking - Räästatugevdus 		2	44x44	600

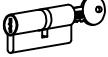

Pos	Piece list - Stückliste - Liste des pièces - Elementi - Stuklijst - Tükitabel 29.03.2023 1494x1850 TUK.2.056.TPVP.MMWcc DGP+C+	1/1	Q	P (mm)	L (mm)
	<p>Glass size - Glasgröße - Taille de la vitre - Misura del vetro - Glas afmeting - Klaasi mõõt: 514x742 mm</p>   <p>1394x1766 mm</p>				
HS1	Screw for georgian bars - Schraube für sprossen - Vis pour croisillons - Viti per unire la griglia georgiana della finestra - Schroeven voor raamverdeling - Kruvi ukse petteliistule		12	2.5x20	
HS4	Screw for door fillet - Schraube zur befestigung türleiste - Vis pour fixation baguette d'arret de porte - Viti per massellino della porta - Schroef voor deurlijst - Kruvi ukse kokkuvaltšiliistule		10	3x30	
HS16	Screw for door jamb - Schraube für türrahmen - Vis de fixation partie haute avec montants du cadre de porte - Viti x fissaggio montanti porte - Schroef voor deurkozijn - Kruvi ukse lengile		4	5x90	
HS25	Screw for doorstep - Schrauben für swelle - Vis pour fixation barre de seuil - Vite per soglia della porta - Schroef voor deurdoorpel - Kruvi lävepakule		3	4.5x65	
MH	Male bolt hinge for door - Türband - Partie male de paumelle de porte - Cerniera anube x porta - Scharnier bout - Reguleeritav polthing isane		6	14x80	
HC	Covers for door hinges - Schutzkappe für türband - Couverture de paumelle de porte - Copertura delle cerniere della porta - Afdek kap voor deurscharnier - Reguleeritava polthinge kate		12		
TL4	Door handle fittings - Türgriff - Poignee de porte - Maniglie - Deurhendel klink - Ukse käepide		1		
TL5	Set of door lock covers - Schlossblenden - Set de garnitures de porte - Copertura serrature - Slot sluitplaat set - Ukse lukuplaat		1		
	Cylinder lock - Zylinderschloss - Barillet de porte - Serratura - Cylinder slot - Ukse lukusüdamik		1	30x35	
	Striker for barrel bolt - Hülse für grendelriegel - Gache au sol du targette - Boccola per fermo della porta - Huls voor vergrendelingsschuif - Vasturaud ukse servariivile		2		